

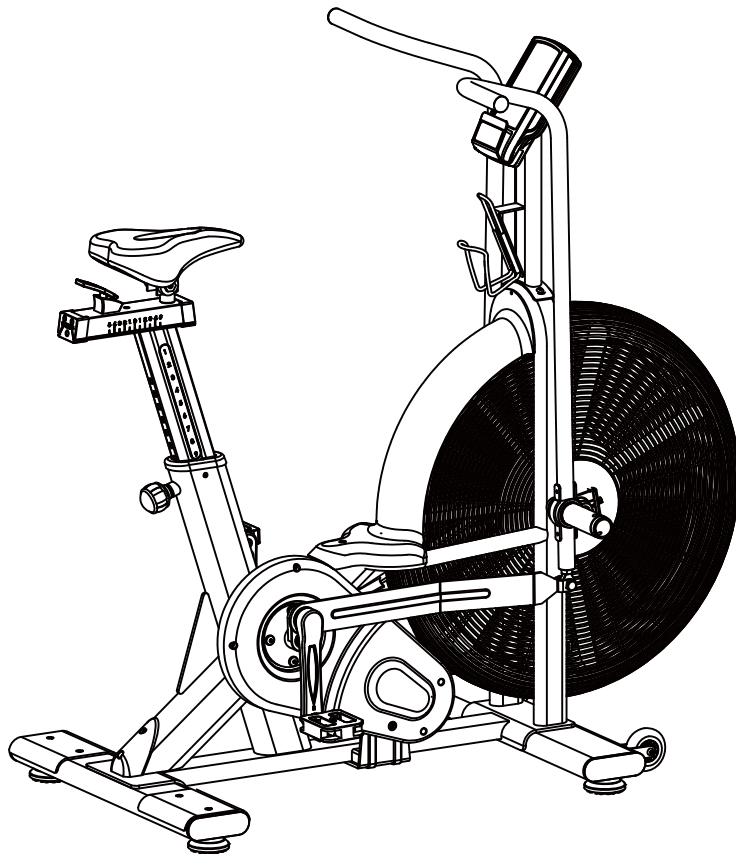

Blitz Air Bike

SKU: BTZBK



ASSEMBLY INSTRUCTIONS



BellsofSteel

Scan QR code for assembly instructions:



www.bellsofsteel.com | www.bellsofsteel.us | Telephone: 1-888-718-7997



Kaevon Khoozani
President

Welcome to Bells of Steel, you've made an excellent choice.

First off I want to say thank you for supporting my small business.

I've spent a lot of time crafting this design to create a fantastic lifting experience to help you reach your full potential and I hope you love your new equipment.

I've done my best to keep the setup of your new gear simple. If you find yourself needing a bit more assistance than the included instructions, check our youtube page for assembly videos or feel free to email us for troubleshooting guidance.

A GUIDE TO SAFETY

We know you are excited to use your new Bells of Steel gear, but please read through this Guide to Safety to ensure you do not hurt yourself or others while exercising. It is your responsibility to ensure that all users of the equipment are informed of all warnings and instructions in this manual. **TO REDUCE THE RISK OF SERIOUS INJURY, READ THE FOLLOWING IMPORTANT PRECAUTIONS BEFORE USING YOUR BELLS OF STEEL PRODUCT.**

- 1 Before starting any exercise program consult your physician. Be aware of your body's signals. Incorrect or excessive exercise can be damaging to your health. **STOP EXERCISING IF YOU EXPERIENCE ANY OF THE FOLLOWING SYMPTOMS: PAIN, TIGHTNESS IN YOUR CHEST, IRREGULAR HEARTBEAT, SHORTNESS OF BREATH, LIGHTHEADEDNESS, DIZZINESS, OR FEELINGS OF NAUSEA. IF YOU EXPERIENCE ANY OF THESE SYMPTOMS, STOP EXERCISING IMMEDIATELY AND CONSULT YOUR PHYSICIAN BEFORE CONTINUING WITH YOUR EXERCISE PROGRAM.**
- 2 It is your responsibility to ensure there is enough space around the product for the intended exercise. Use the product on a flat surface and ensure at least 2 feet (60 cm) of free space around it.
- 3 Children and pets must not be let on or near the product. Moving parts and heavy features of the product can be dangerous and cause serious injury.
- 4 Read all instructions in this manual before using the product and use the product only as described in this manual.
- 5 It is your responsibility to ensure that all users of the product are adequately informed of all precautions, have read and understand all warnings, and are informed how to use the product properly.
- 6 Keep hands and feet from moving parts. Do not lean or rest on the product.
- 7 Wear athletic shoes for foot protection while exercising.
- 8 Your product is intended for use in cool, dry conditions. You should avoid storage in extreme cold, hot, or damp areas.
- 9 This product is designed for indoor use only.
- 10 Ensure that any weight pins that may be included with your product are completely inserted into an appropriate weight plate.
- 11 Ensure that any handles that may be included with your product are attached securely before using the product.
- 12 Ensure that any nuts and bolts that may be included with your product are securely tightened before use. Regularly re-tighten nuts and bolts.
- 13 Ensure any cables that may be included with your product always remain attached to their proper pulleys. If a cable bind occurs during exercise, stop immediately and inspect the part to ensure any interference is fixed.
- 14 Do not overexert yourself during any exercise program. Operate the product as intended.
- 15 The product should be anchored where required or whenever possible. The product should be secured when not in use.
- 16 The product is very heavy. Improper use or assembly can lead to serious injury or death.
- 17 **SAVE AND REVIEW THESE INSTRUCTIONS.**

Now...

LET THE GAINZ BEGIN





Be sure to leave a review on our website or Amazon, we read all feedback and use it to improve our products and service.

For full warranty info visit

<https://www.bellsofsteel.com/warranty/>

Not happy with your purchase or even just changed your mind?

We offer a 30 day money back guarantee

<https://www.bellsofsteel.com/money-back-guarantee/>

Want to learn the best way to use your new products and maximize your Gainz? Subscribe to our YouTube channel for new how to's and workout videos weekly

<https://www.youtube.com/user/bellsofsteel>



www.bellsofsteel.com | www.bellsofsteel.us

EXPLODED-VIEW & PARTS LIST:

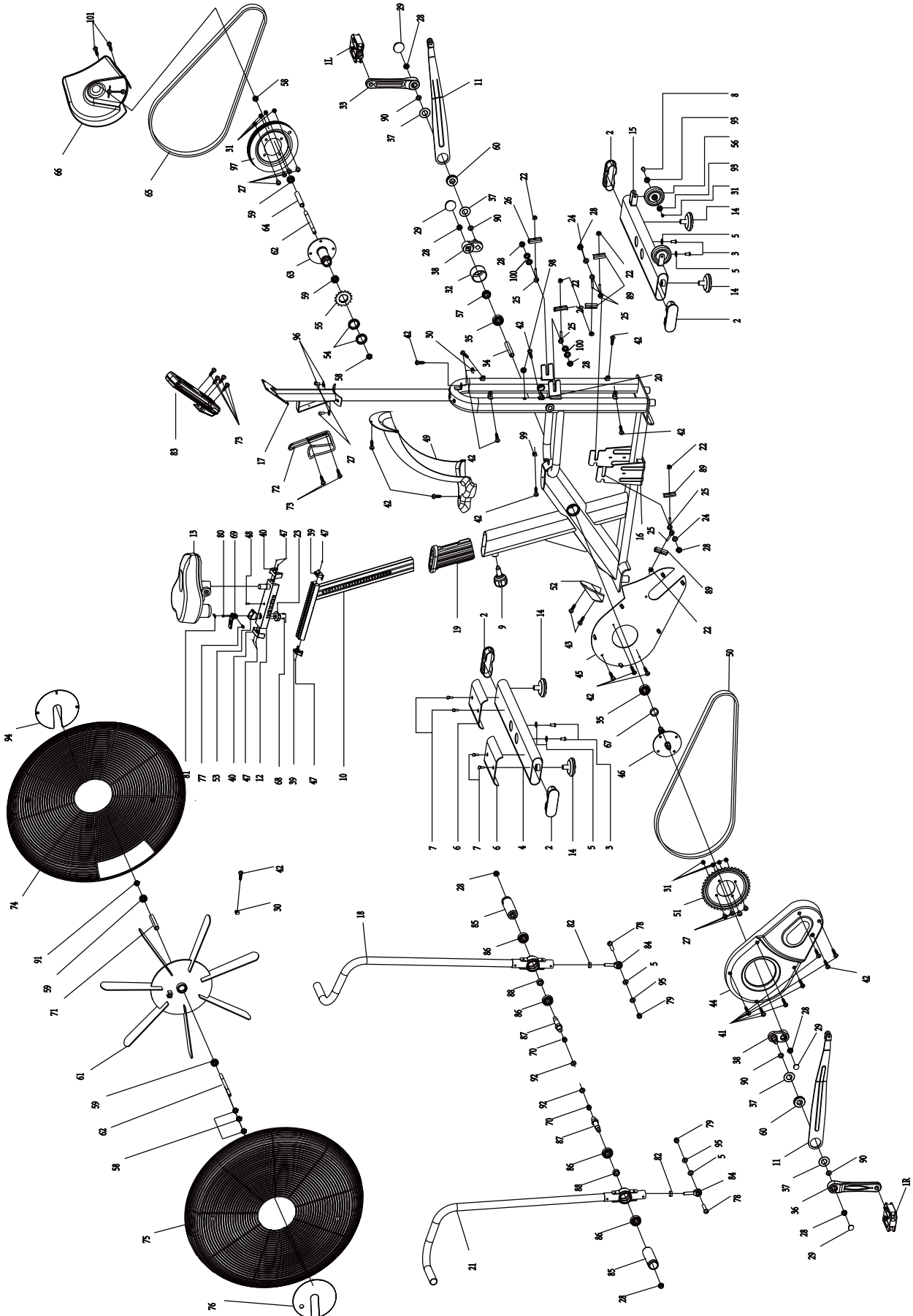

NO	NAME	QUANTITY	SPEC
1	PEDAL	1	JD-304V (9/16")
2	END CAP3	4	120*40*35
3	BOLT 1	4	M10*30
4	REAR STABILIZER	1	WELDING
5	FLAT WASHER	6	10
6	FRONT COVER	2	160*128*3
7	BOLT 1	4	GB/845-85 ST4.8X19
8	BOLT 2	2	M8*40
9	SHAPE KNOB	1	φ50*91 (M16*35)
10	VERTICAL SEAT POST	1	WELDING
11	Drive assembly	2	WELDING
12	SEAT POST	1	WELDING
13	SEAT	1	DD-004
14	STOPPER	4	φ70*41/(M16X25)
15	FRONT STABILIZER	1	WELDING
16	MAIN FRAME	1	WELDING
17	Electronic watch connecting assembly	1	WELDING
18	The left handlebar assembly	1	WELDING
19	PLASTIC SLEEVE	1	103*53.5*178
20	SENSOR	1	SR-202
21	Right handlebar assembly	1	WELDING
22	NUT	6	M6
23	FIXING NUT 2	1	φ44.8*16.5
24	FLAT WASHER	2	12
25	FIXING BOLT	2	M6*58
26	Pull out the fixed piece	2	δ3
27	BOLT 1	10	M8*16
28	NUT	10	M12X1.25
29	CRANK END CAP	4	φ28*6.5
30	Sprocket buckle	9	δ1
31	NUT	10	GB/T 889.1-2000 M8
32	PLASTIC RING	1	φ56*28
33	LEFT CRANK	1	170*15
34	LONG FIXING TUBE	1	φ25*φ20.2*41.2
35	BEARING	2	6004ZZ
36	RIGHT CRANK	1	170*15
37	Outer spring	4	42
38	Crank drive assembly	2	80*65
39	COVER	2	56*23.6*24.6
40	COVER	2	58*36.3*22.7
41	SCREW 1	6	GB/T 845-1985 ST4.2*19
42	SCREW 2	12	GB/T 845-1985 ST4.2*19
43	SCREW 3	11	GB/845-85 ST4.8X19
44	CHAIN COVER 1	1	478*270*60
45	CHAIN COVER 2	1	469*241*23
46	AXIS	1	φ20*162
47	BOLT 7	6	M4*12
48	BOLT 8	1	M5*18
49	Sweat proof cover	1	438*194*399
50	SHORT CHAIN WHEEL	1	P=12.7, 66

NO	NAME	QUANTITY	SPEC
51	BELT WHEEL	1	P=12.7,Z=52T
52	FRONT COVER	1	122*56*45
53	Handle base	1	41.5*30*30
54	LOCK NUT	2	M33*1*4
55	CHAIN WHEEL 1	1	A7K-16 1/2"*1/8" 16T (1.37")
56	WHEEL	2	φ75*24
57	FIXING NUT	1	M20*1.0
58	FIXING NUT 2	3	M12X1.25 H=6
59	BEARING	4	6001ZZ
60	BEARING	2	6004ZZ
61	Rim assembly	1	φ640*69
62	FLYWHEEL SHAFT	1	φ12*160
63	Double drive assembly	1	φ110*107
64	Double drive inner sleeve	1	φ16*φ12.2*91.1
65	BELT	1	5PK1346
66	CHAIN COVER 3	1	248*269*80
67	SHORT FIXING TUBE	1	φ25*φ20.5*9
68	BOLT 1	2	GB/845-85 M4*12
69	Handle	1	79*32*32.6
70	NUT	2	GB/T 889.1-2000 M16 H=12
71	Flywheel inner casing	1	φ16*φ12.2*53.1
72	BOTTLE HOLDER	1	φ6
73	SCREW 3	6	GB/T 5780-2000 M5*10
74	The left wheel cover	1	φ690*55
75	Right wheel cover	1	φ690*55
76	Fan baffle	1	φ170*10
77	Handle rotary copper sleeve	1	φ12*20
78	BOLT 3	2	M10*45
79	NUT	2	GB/T 889.1-2000 M10
80	BOLT 16	1	M6*35
81	Handle cover	1	φ16.4*10.3*5.5
82	LITTLE RUBBER	2	19.6*15.6*13.7
83	COMPUTER	1	JSD-10421
84	Universal joint	2	70*28 (M10)
85	Foot lever	2	φ38*120(M16*1.5)
86	BEARING	4	6203ZZ
87	Foot lever	2	φ22*110(M16*1.5)
88	Foot lever bushing	2	φ24*φ17.2*11.1
89	Small retaining plate	4	δ3
90	corrugated gasket	4	φ20
91	FIXING NUT 1	1	M12X1.25 H=10
92	SPRING WASHER 2	2	GB/T 859-1987 16
93	BEARING	4	608ZZ
94	Fan baffle	1	φ170*10
95	SPRING WASHER	2	GB/T 859-1987 10
96	SPRING WASHER 2	10	GB/T 859-1987 8
97	BELT WHEEL	1	φ200*21
98	Plastic plug	1	φ14*14
99	NUT	4	GB/T 889.1-2000 M10 H=10
100	Serrated gasket	4	GB/T 95-2002 12
101	SCREW 2	2	GB/T 845-1985 ST4.2*25

ASSEMBLY INSTRUCTION:

1.PREPARATION:

- A. Before assembling make sure that you will have enough space around the item.
- B. Use the present tooling for assembling.
- C. Before assembling please check whether all needed parts are available (at the above of this instruction sheet you will find an explosion drawing with all single parts (marked with numbers) which this item consists of.

2.ASSEMBLY INSTRUCTION:

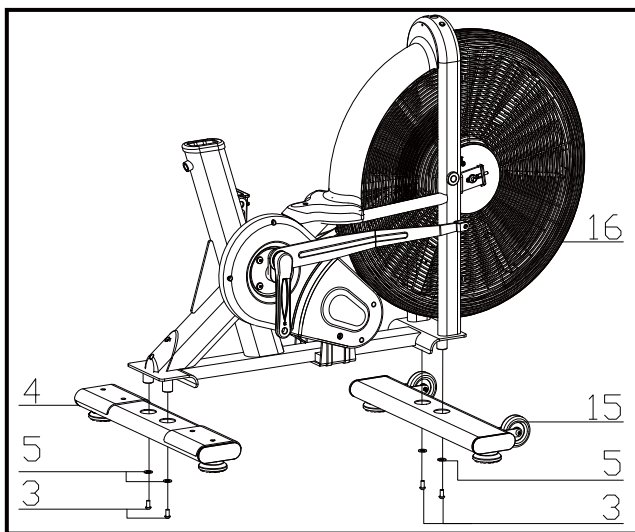

FIG.1

FIG.1:

Attach the Front Stabilizer (pt.15) to the Main Frame (pt.16) using two sets of Ø10 Flat Washers (pt.5) and bolt 1 (3).

Attach the Rear Stabilizer (pt.4) to the Main Frame (pt.16) using two sets of Ø10 Flat Washers (pt.5) and bolt 1 (3)

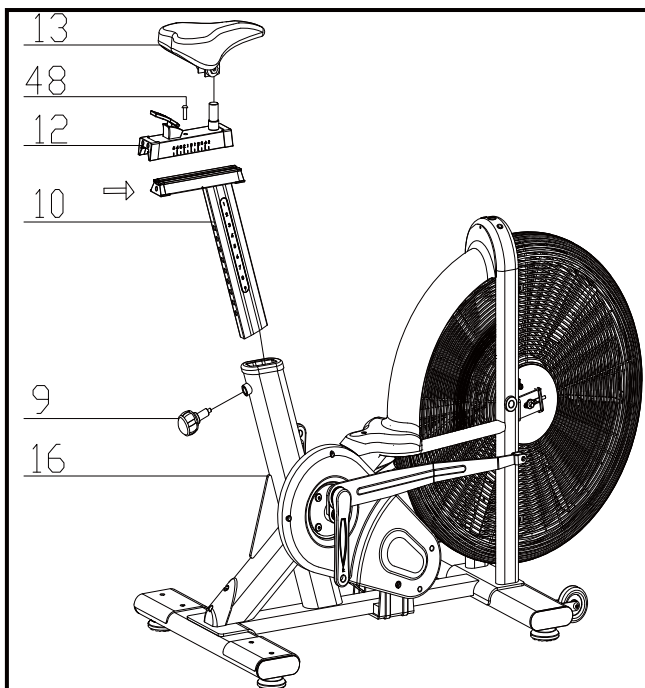

FIG.2

FIG.2:

Slide the Vertical Seat Post (pt.10) into the seat post housing on the main frame (pt.16). And put the knob up, then release the round nut(pt.48) , Then slide the Seat Post (pt.12) into the Vertical Seat Post (pt.10),Then fixing the bolt8 (pt.48), You will have to slacken the knurled section of the Adjustment Knob (pt.9) and pull the knob back and then select the desired height. Release the knob and retighten the knurled portion.

Now fix the Seat (pt.13) to the Seat Post (pt.12) as shown, and tighten the bolts around the screws under the seat.

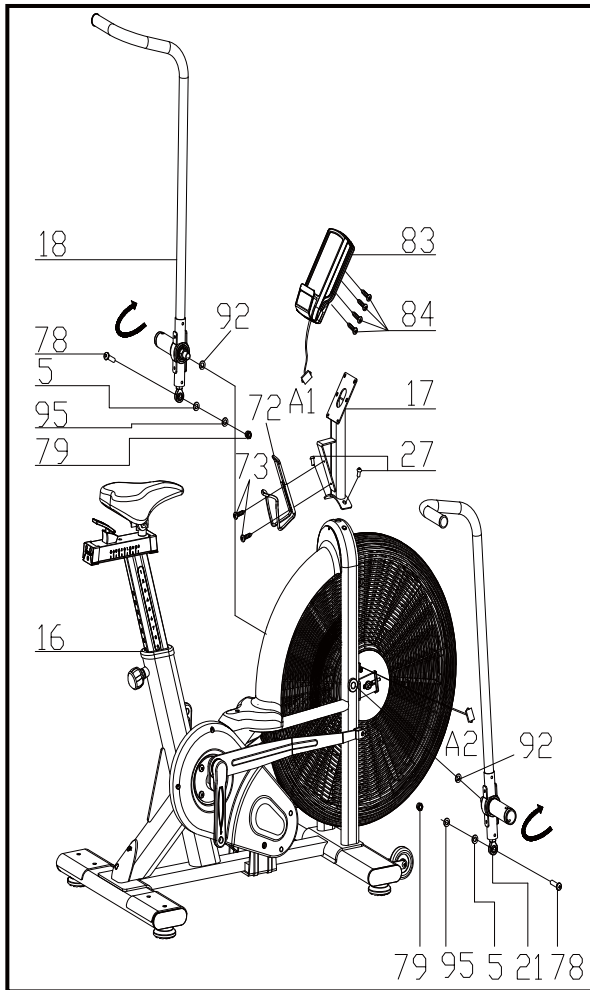

FIG.3

FIG.3:

The left hand assembly (18), the right wrench assembly (21) and the outer tooth type gasket (92) are fixed to the main frame assembly (16) in accordance with the graphic method, the inner six angle flat head screws (78), flat washer (5), Spring washer (95), the lock nut (79) drive assembly connected then, locking; electronic connection assembly (17) with six angle flat head screws (27) fixed to the main frame assembly (16), the cross slot screw (73) will Aluminum Alloy kettle (72) fixed to the main frame assembly (16) on, ATTENTION: YOU SHOULD FIX THE HANDLEBAR TIGHTLY

The electronic meter assembly (83) with cross slot screw (84) fixed to the electronic connection assembly (17), connect the plug (A1&A2),

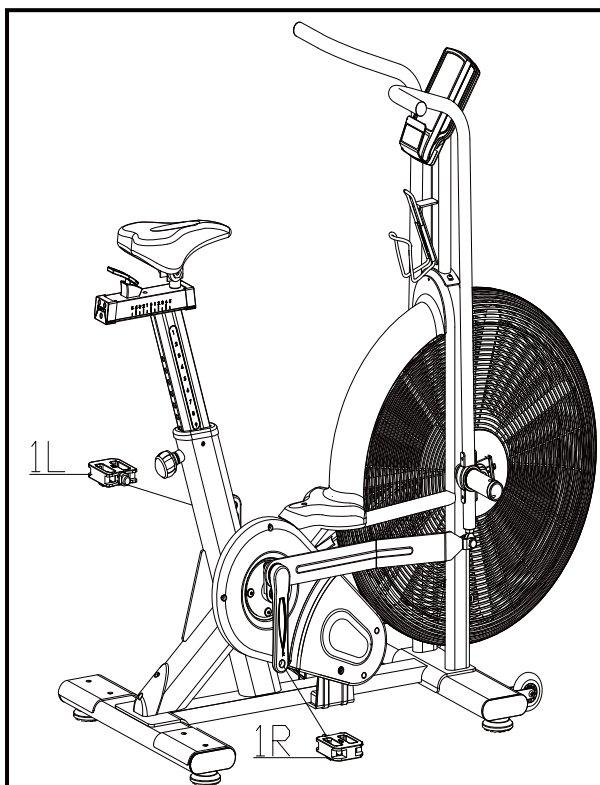

FIG.4

FIG.4:

The Pedals (pt.1 L & pt.1 R) are marked "L" and "R" - Left and Right. Connect them to their appropriate crank arms. The right crank arm is on the right-hand side of the cycle as you sit on it. Note that the Right pedal should be threaded on clockwise and the Left pedal anticlockwise.

ADJUSTMENT

***To adjust the seat height, slacken the spring knob on the vertical post stem on the main frame and pull back the knob. Position the vertical seat post for the desired height so that holes are aligned, then release the knob and retighten it.**

***To move the seat forward in the direction of the handlebar or backwards away from it, loosen the adjusting knob and washer and pull the knob back. Slide horizontal seat post into desired position. Align holes and then retighten the adjusting knob.**

Monitor Instruction Manual

DISPLAY FUNCTIONS

TIME	DESCRIPTION
RPM	• Display the rotation per minute with range from 0~ 199.
SPEED	• Display current training speed. Maximum speed is 99.9 KM/H or ML/H.
TIME	• Count up - No preset target, Time will count up from 00:00 to maximum 1:59:59 with each increment is 1 minute. • Count down – The console will countdown from preset time to 00:00:00 and each preset increment or decrement will be 1 minute between 00:01:00 to 1:59:00.
DISTANCE	• Accumulates total distance from 0.0 up to 999.9 KM or ML or count down from preset value. User may preset target distance value with UP/DOWN key. Each increment is 1.0KM or ML.
CALORIES	• Accumulates calories consumption or count down during training from 0 to maximum 999 calories. User may preset target Calories with UP/DOWN key.
WATT	• Display the power consumption during training. • Display Range: 0~1999.
PULSE	• User may set up target pulse value from 0~30 to 230 and the console buzzer will beep when the actual heart rate is over the target value during workout.

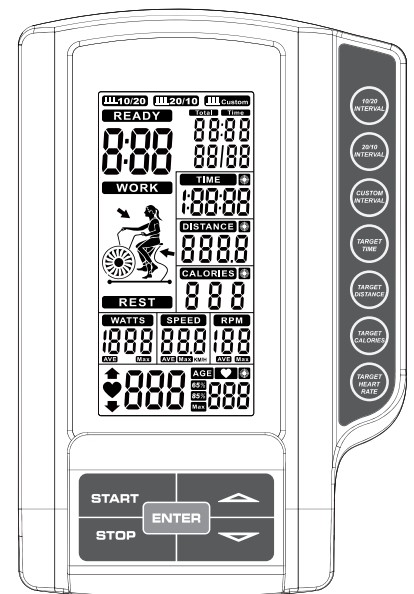

BUTTON FUNCTION

TIME	DESCRIPTION
START	• To start workout quickly or resume workout in Stop mode.
STOP	• To stop/pause workout. • To clear up all settings. • Hold on this key for 2 seconds to reboot the console
DOWN	• To adjust Distance, Calories, Heart-rate, Time, Age value down.
UP	• To adjust Distance, Calories, Heart-rate, Time, Age value up.
Target Distance	• Fast access to Target Distance training mode.
Target Calories	• Fast access to Target Calories training mode.
Target Heart-rate	• Fast access to Target Heart Rate training mode.
Target Time	• Fast access to Target Time training mode.
Interval	• There are 3 programs: INTERVAL 10/20, INTERVAL 20/10, Custom.
ENTER	• To confirm settings or enter program.

OPERATION INSTRUCTION

- When POWER ON, LCD will full display 2s (Figure 1) with long beep sound, then display wheel diameter 1s in DIST area (Figure 2). Then enter into AGE setting mode, the AGE flashing to be set (Figure 3). Press the UP/DOWN to set age and press ENTER to confirm then go to Standby mode.

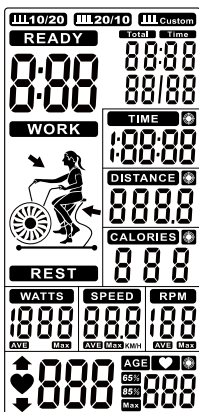

Figure 1

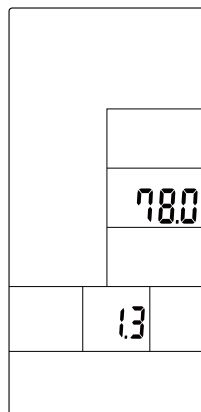

Figure 2

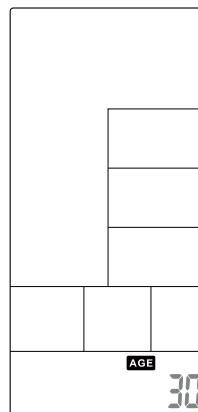



Figure 3

2. The window of **INTERVAL10/20**, **INTERVAL10/20**, **INTERVAL CUSTOM**, **READY**, **WORK**, **REST**, **TIME**, **DISTANCE**, **CALORIES**, **WATTS**, **SPEED**, **RPM** and  will flash by sequence in every 1s (Figure 4~Figure 16). If no input of key operation or RPM signal or pulse input for 60s, computer will go to Sleeping mode.

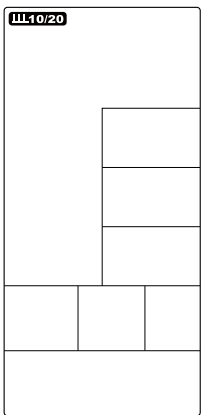

Figure 4

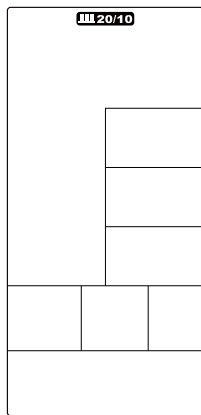

Figure 5

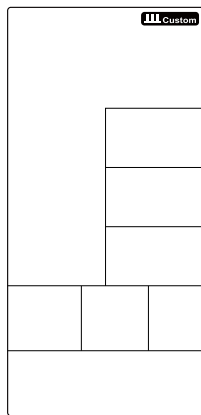

Figure 6

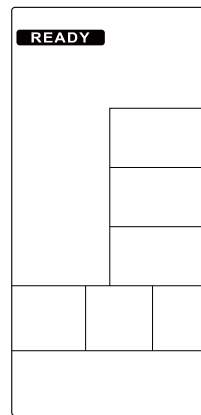

Figure 7

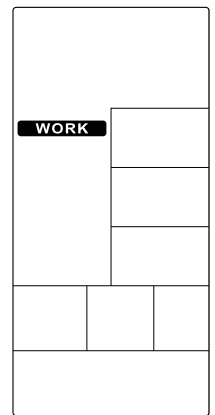

Figure 8

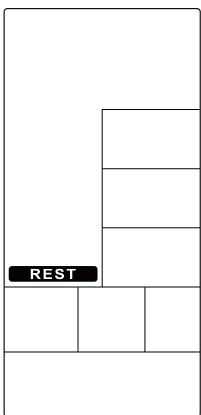

Figure 9

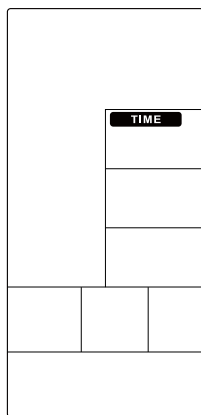

Figure 10

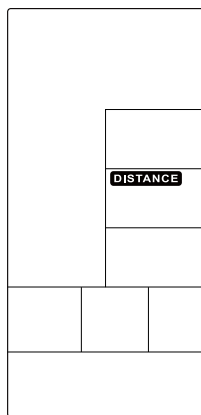

Figure 11

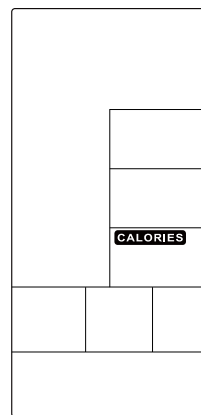

Figure 12

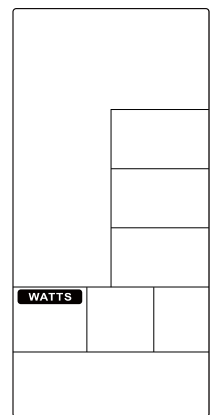

Figure 13

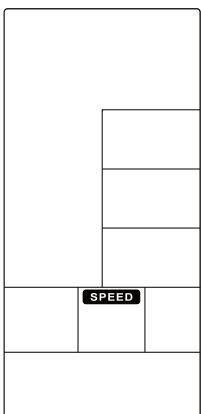

Figure 14

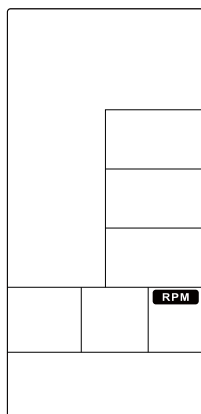

Figure 15

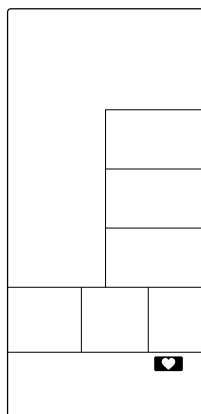

Figure 16

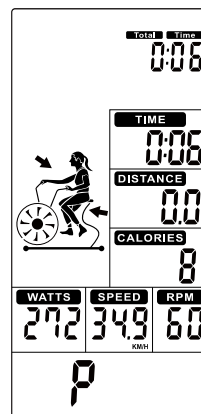

Figure 17

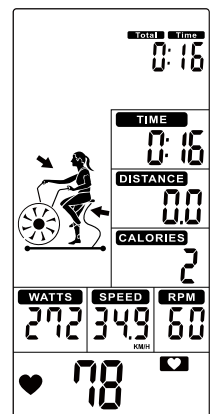

Figure 18

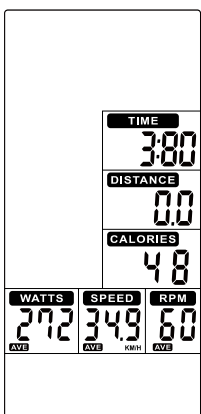

Figure 19

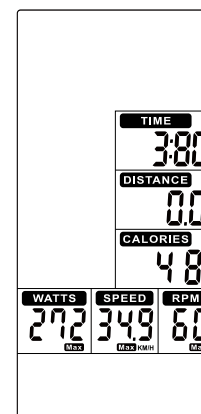

Figure 20

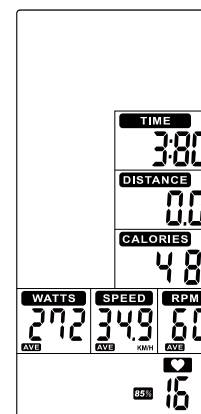

Figure 21

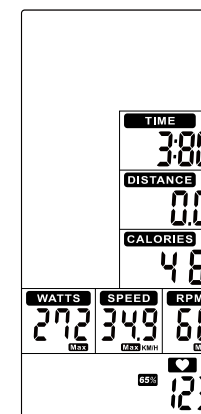

Figure 22

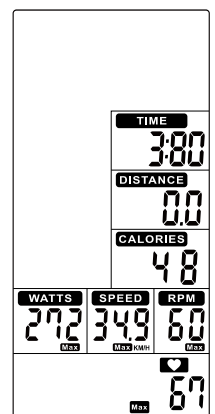



Figure 23

3. Select **Manual, Interval, Target Distance, Target Calories, Target HR, Target Time** program:

3.1 Manual mode:

- ① In Standby mode, press START to start workout quickly, the buzzer sound 1 second. TOTAL TIME/ TIME/ DISTANCE/ CALORIES/ WATTS/ SPEED/ RPM start to count up (Figure 17).
- ② Whenever there is Pulse signal input,  will light up and  symbol will flash and display pulsevalue (Figure 18). Without pulse input, it will display "P" (Figure 17).
- ③ No signal input for 30s, buzzer sounds 1 short beep and enter to Wake-up mode. Press any to wake up the console.
- ④ Press START key once to pause training, Buzzer will sound for 0.5s in every 30s. All values are displaying on LCD and flashing in every 4s. If continue to stop training for 5 minutes, buzzer sounds 2s and enter to Wake-up mode. Press START to resume workout.
- ⑤ Press STOP key, TIME will display total workout time; DISTANCE will display total workout distance; CALORIES will display total consumption during workout; WATT, SPEED and RPM will switch to display AVG. & MAX. PULSE window will switch to display 65%, 85% MAX (Figure 21~23) each 5s.
- ⑥ With pulse signal input, PULSE window will display user actual pulse. Pulse window displays nothing if no pulse signal input (Figure 19~20).
- ⑦ Press any PROGRAM key then perform the program accordingly.

3.2 Interval 20/10 mode:

- ① Press INTERVAL key to select INTERVAL20/10, press ENTER then **INTERVAL20/10** will light up, alongwith a long sound for 1s.
- ② Cycle time counts down from 3 to 0 then console start, meanwhile buzzer beeps once per second and **READY** flashes once per second, counting displays '00/08'(Figure 24).
- ③ Cycle time counts down from 20 to 0 and **WORK** flashes once per second . Meantime windows displays rotation animation and count down from 4 minutes. Then TOTAL TIME, DISTANCE, CALORIES, WATTS, SPEED & RPM start calculating, counting displays '01/08'(Figure 25).
- ④ Cycle time counts down from 10 to 0 and **REST** flashes once per second along with 10 beeps(Figure 26), meanwhile **READY** will flash in last 3s (Figure 27).
- ⑤ The above ③&④ continue cycle counting and add 1 per each cycle,until displays 08/08**WORK**, then go to End page.
- ⑥ Press START button once enter into PAUSE mode, Buzzer will sound for 0.5s in every 30s. All values are displaying on LCD and flashing in every 4s. If continue to stop training for 5 minutes, buzzer sounds 2s and enter to Wake-up mode. Press START to resume workout.
- ⑦ Press STOP or end up training, buzzer beeps 1s then displays TOTAL TIME, DISTANCE,CALORIES for 30s, and WATT, SPEED & RPM will switch to display AVG. & MAX. PULSE window will switch to display 65%, 85% MAX (Figure 21~23) each 5s.
- ⑧ With pulse signal input, PULSE window will display user actual pulse and 65%, 85% MAX (Figure 21~23). Pulse window displays nothing if no pulse signal input (Figure 19~20).
- ⑨ Press any PROGRAM key then perform the program accordingly.

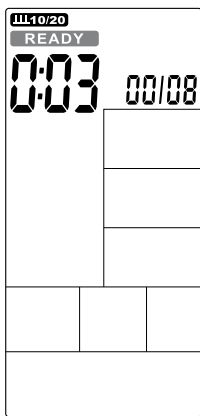

Figure 24

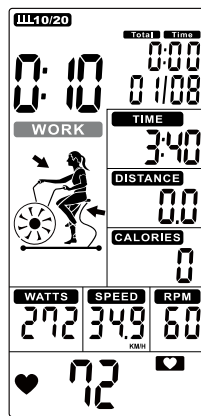

Figure 25



Figure 26

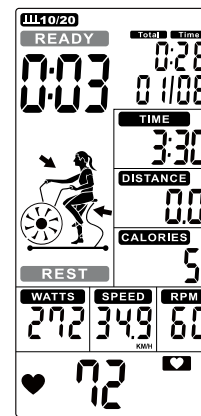

Figure 27

3.3 Interval 10-20 mode:

- ① Press INTERVAL to select INTERVAL10/20, press ENTER then **INTERVAL10/20** will light up along with buzzer beeps 1s.
- ② Cycle time counts down from 3 to 0 then console start, meanwhile buzzer beeps once per second and **READY** flashes once per second, counting displays '00/08'(Figure 28).
- ③ Cycle time counts down from 10 to 0 and **WORK** flashes once per second . Meantime REMAINING will light up and count down from 4 minutes. Then TOTAL TIME, DISTANCE, CALORIES, WATTS, SPEED & RPM start calculating, counting displays '01/08'(Figure 29).
- ④ Cycle time counts down from 20 to 0 and **REST** flashes once per second along with beeps (Figure 30), meanwhile READY will flash in last 3s(Figure 31).
- ⑤ The above ③&④ continue cycle counting and add 1 per each cycle, until displays 08/08**WORK**, then go to End page.
- ⑥ Press START button once enter into PAUSE mode, Buzzer will sound for 0.5s in every 30s. All values are displaying on LCD and flashing in every 4s. If continue to stop training for 5 minutes, buzzer sounds 2s and enter to Wake-up mode. Press START to resume workout.
- ⑦ Press STOP or end up training, buzzer beeps 1s then displays TOTAL TIME, DISTANCE,CALORIES for 30s, and WATT, SPEED & RPM will switch to display AVG. & MAX. .PULSE window will switch to display 65%, 85% MAX (Figure 21~23) each 5s.
- ⑧ With pulse signal input, PULSE window will display user actual pulse. Pulse window displays nothing if no pulse signal input (Figure 19~20).
- ⑨ Press any PROGRAM key then perform the program accordingly.

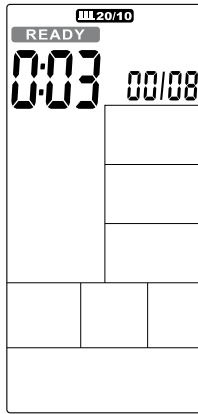

Figure 28

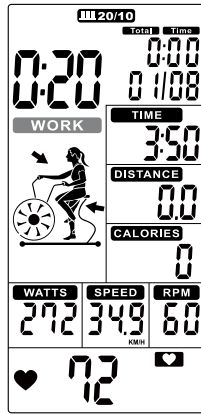

Figure 29



Figure 30

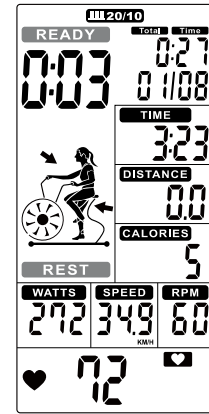

Figure 31

3.4 Interval CUSTOM:

- ① Press INTERVAL to select INTERVAL CUSTOM, press ENTER to enter into this mode then **INTERVAL CUSTOM** 00/XX flashes to be set along with buzzer beeps 1s. Press UP/DOWN to set 00/XX within 1~99 circularly. Press ENTER to confirm along with buzzer beeps 1s then enter into next setting.(Figure 32)
- ② The TIME continues lighting up, **WORK** and 0:01 will flash, press UP/DOWN to set training time within 0:00~9:59 circularly (Figure 33). Press ENTER to confirm along with buzzer beeps 1s and **INTERVAL CUSTOM** continues lighting up.
- ③ The TIME continues lighting up, **REST** will flash, press UP/DOWN to set rest time 0:01~9:59 circularly (Figure 34). Press ENTER to confirm along with buzzer beeps 1s and **INTERVAL CUSTOM** continues lighting up.
- ④ Cycle time counts down from 3 to 0 then console start, meanwhile buzzer beeps once per second and **READY** flashes once per second, counting displays '00/XX'(Figure 35).
- ⑤ Cycle time counts down from the preset total time and **WORK** flashes once per second . Then TOTAL TIME, DISTANCE, CALORIES, WATTS, SPEED & RPM start calculating, counting displays '01/XX'(Figure 36).
- ⑥ Cycle time counts down from and **REST** flashes once per second along with buzzer beeps(Figure 37), meanwhile **READY** will flash in last 3s(Figure 38).
- ⑦ The above ③&④ continue cycle counting and add 1 per each cycle, until the WORK setting value finished then go to End page.
- ⑧ In **WORK** mode, buzzer beeps 1s then enter into wake up mode if no any signal inputs within 30s.
- ⑨ Press START button once enter into PAUSE mode, Buzzer will sound for 0.5s in every 30s. All values are displaying on LCD and flashing in every 4s. If continue to stop training for 5 minutes, buzzer sounds 2s and enter to Wake-up mode. Press START to resume workout.
- ⑩ Press STOP or end up training, buzzer beeps 1s then displays TOTAL TIME, DISTANCE, CALORIES for 30s, and WATT, SPEED & RPM will switch to display AVG. & MAX. PULSE window will switch to display 65%, 85% MAX (Figure 21~23) each 5s.
- ⑪ With pulse signal input, PULSE window will display user actual pulse. Pulse window displays nothing if no pulse signal input (Figure 19~20).
- ⑫ Press any PROGRAM key then perform the program accordingly.

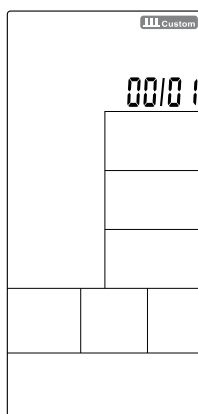

Figure 32

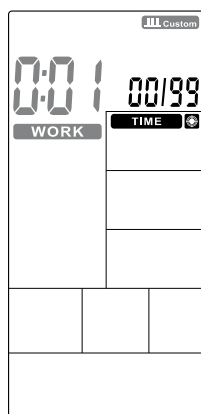

Figure 33

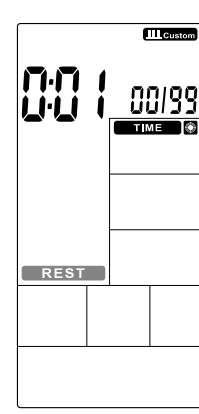

Figure 34

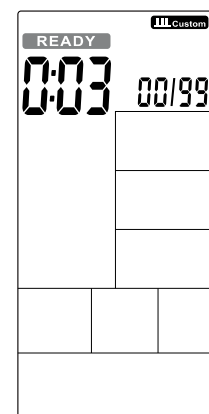

Figure 35

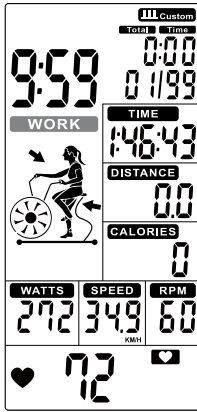

Figure 36

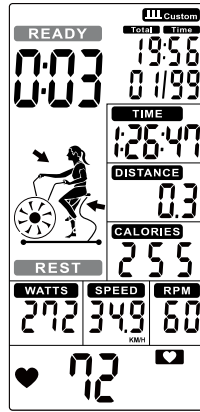

Figure 37

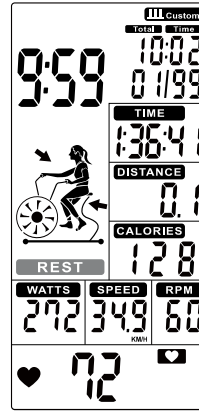

Figure 38

3.5 Target TIME mode:

- ① In Standby mode, press Target Time key and **TIME** will light up, along with a long sound for 1s.
- ② TIME value is flashing, press UP and DOWN to adjust value (Figure 39) and press ENTER to confirm meanwhile buzzer beeps 1s and **TIME** lasting lighting up.
- ③ Preset TIME value counts down, DISTANCE, CALORIES, WATTS, SPEED, RPM start to count up. (Figure 40)
- ④ Press START button once enter into PAUSE mode, Buzzer will sound for 0.5s per second within 30s. All values are displaying on LCD and flashing in every 2s. If continue to stop training for 5 minutes, buzzer sounds 2s and enter to Wake-up mode. Press START to resume workout.
- ⑤ No signal inputs for 30s, buzzer sounds 1 short beep and enter to Wake-up mode.
- ⑥ Press STOP or end up training, TIME will display total workout time; DISTANCE will display total workout distance; CALORIES will display total consumption during workout; WATT, SPEED and RPM will switch to display AVG. & MAX. PULSE window will switch to display 65%, 85% MAX (Figure 21~23) each 5s.
- ⑦ With pulse signal input, PULSE window will display user actual pulse. Pulse window displays nothing if no pulse signal input (Figure 19~20).
- ⑧ Press any PROGRAM key then perform the program accordingly.

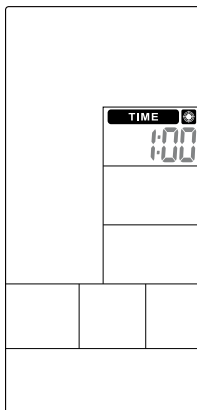

Figure 39

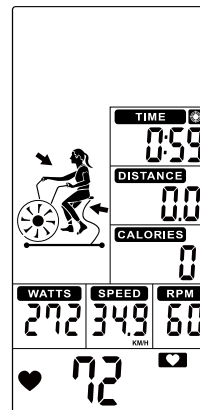

Figure 40

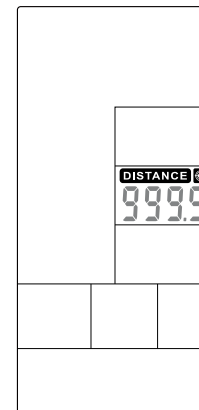

Figure 41

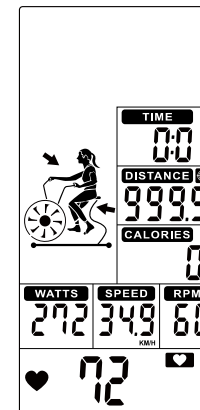

Figure 42

3.6 Target Distance mode:

- ① In Standby mode, press Target Distance key and **DISTANCE** will light up, along with a long sound for 1s.
- ② DISTANCE value is flashing, press UP and DOWN to adjust (Figure 41). Press ENTER to confirm meanwhile buzzer beeps 1s and **DISTANCE** lasting lighting up.
- ③ Preset DISTANCE value counts down, TIME, CALORIES, WATTS, SPEED, RPM start to count up. (Figure 42)
- ④ Press START button once enter into PAUSE mode, Buzzer will sound for 0.5s per second within 30s. All values are displaying on LCD and flashing in every 2s. If continue to stop training for 5 minutes, buzzer sounds 2s and enter to Wake-up mode. Press START to resume workout.
- ⑤ No signal input for 30s, buzzer sounds 1s and enter to Wake-up mode.
- ⑥ Press STOP key or end up training, TIME will display total workout time; DISTANCE will display total workout distance; CALORIES will display total consumption during workout; WATT, SPEED and RPM will switch to display AVG. & MAX. PULSE window will switch to display 65%, 85% MAX (Figure 21~23) each 5s.
- ⑦ With pulse signal input, PULSE window will display user actual pulse. Pulse window displays nothing if no pulse signal input (Figure 19~20).
- ⑧ Press any PROGRAM key then perform the program accordingly.

3.7 Target Calories mode:

- ① In Standby mode, press Target Calories key and **CALORIES** will light up, along with a long sound for 1s.

- ② CALORIES value is flashing, press UP and DOWN to adjust (Figure 43). Press ENTER to confirm meanwhile buzzer beeps 1s and CALORIES last lighting up
- ③ Preset CALORIES value counts down, TIME, DISTANCE, WATTS, SPEED & RPM start to count up. (Figure 44)
- ④ Press START button once enter into PAUSE mode, Buzzer will sound for 0.5s per second within 30s. All values are displaying on LCD and flashing in every 2s. If continue to stop training for 5 minutes, buzzer sounds 2s and enter to Wake-up mode. Press START to resume workout.
- ⑤ No signal input for 30s, buzzer sounds 1s and enter to Wake-up mode.
- ⑥ Press STOP key or end up training, TIME will display total workout time; DISTANCE will display total workout distance; CALORIES will display total consumption during workout; WATT, SPEED and RPM will switch to display AVG. & MAX. PULSE window will switch to display 65%, 85% MAX (Figure 21~23) in each 5s.
- ⑦ With pulse signal input, PULSE window will display user actual pulse. Pulse window displays nothing if no pulse signal input (Figure 19~20).
- ⑧ Press any PROGRAM key then perform the program accordingly.

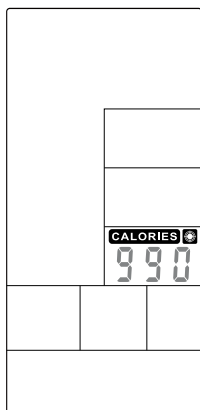

Figure 43

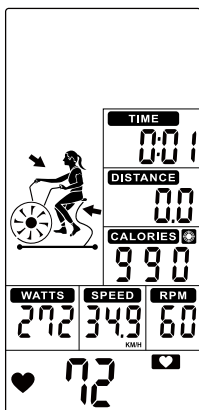

Figure 44

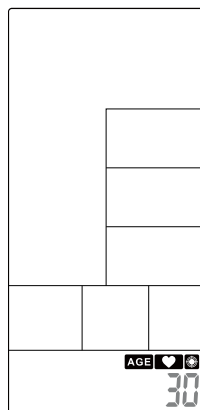

Figure 45

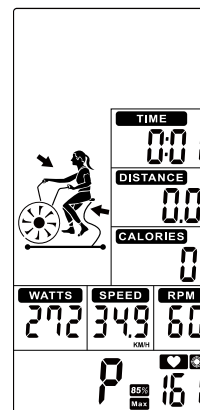

Figure 46

3.8 Target HR mode:

- ① In Standby mode, press Target Heart-Rate key and AGE will light up, along with along sound for 1s.
- ② AGE value is flashing, press UP and DOWN to preset your Age (Figure 45). Press ENTER to confirm along with buzzer beeps 1s and HEART RATE last lighting up.
- ③ When start workout, MAX HR lights up, 65% & 85% Heart rate will switch to display. TIME/ DISTANCE/ CALORIES/ WATTS/ SPEED/ RPM will calculate workout value (Figure 46).
- ④ When Heart Rate goes below to 65%, 65% & value will flash. And buzzer sounds in every 10s until user HR achieve above 65% (Figure 47).
- ⑤ When Heart Rate exceeds to 85%, 85% & value will flash. And buzzer sounds in every 10s until user HR goes below 85% (Figure 48).
- ⑥ When Heart Rate goes between 65% ~ 85%, only HEART RATE will flash (Figure 49).
- ⑦ No signal input for 30s, buzzer sounds 1 short beep and enter to Wake-up mode.
- ⑧ Press START button once enter into PAUSE mode, Buzzer will sound for 0.5s per second within 30s. All values are displaying on LCD and flashing in every 2s. If continue to stop training for 5 minutes, buzzer sounds 2s and enter to Wake-up mode. Press START to resume workout.
- ⑨ Press STOP again or end up training in 15s, TIME will display total workout time; DISTANCE will display total workout distance; CALORIES will display total consumption during workout; WATT, SPEED and RPM will switch to display AVG. & MAX. PULSE window will switch to display 65%, 85% MAX (Figure 21~23) each 5s.
- ⑩ With pulse signal input, PULSE window will display user actual pulse. Pulse window displays nothing if no pulse signal input (Figure 19~20).
- ⑪ Press any PROGRAM key then perform the program accordingly.

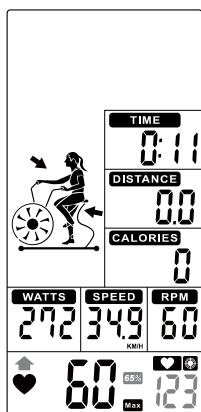

Figure 47

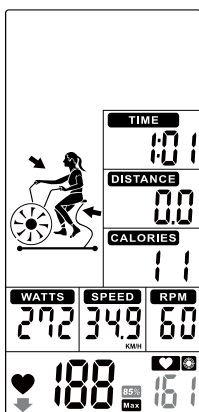

Figure 48

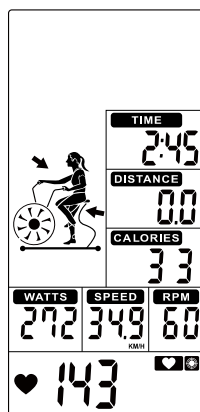

Figure 49

OPTION SETTING:

SETTING mode-

1. Hold on START & ENTER key for 2s, buzzer will sound 1 long beep. SPEED keep lighting up, M/H, KM/H flash once per second (Figure 50~51).
2. Press UP or DOWN to select KM/H or M/H, press ENTER to confirm then skip to Standby mode.
3. No action to console for 30s, it will go to Standby mode.

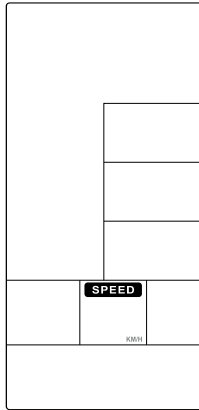

Figure 50

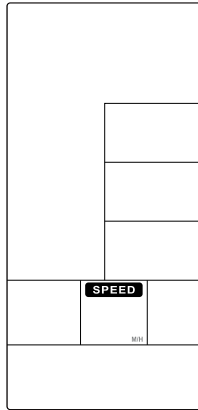

Figure 51

RESET mode-

1. In any mode, press STOP for 2s, system will do TOTAL RESET.
2. LCD flash in every 2 seconds, buzzer sound for 2 seconds.
3. Reverse to Standby page, all setting resume to preset value.

SLEEPING mode-

In Standby mode, if no key press/RPM/pulse input for 30s, console will go to SLEEPING mode.