

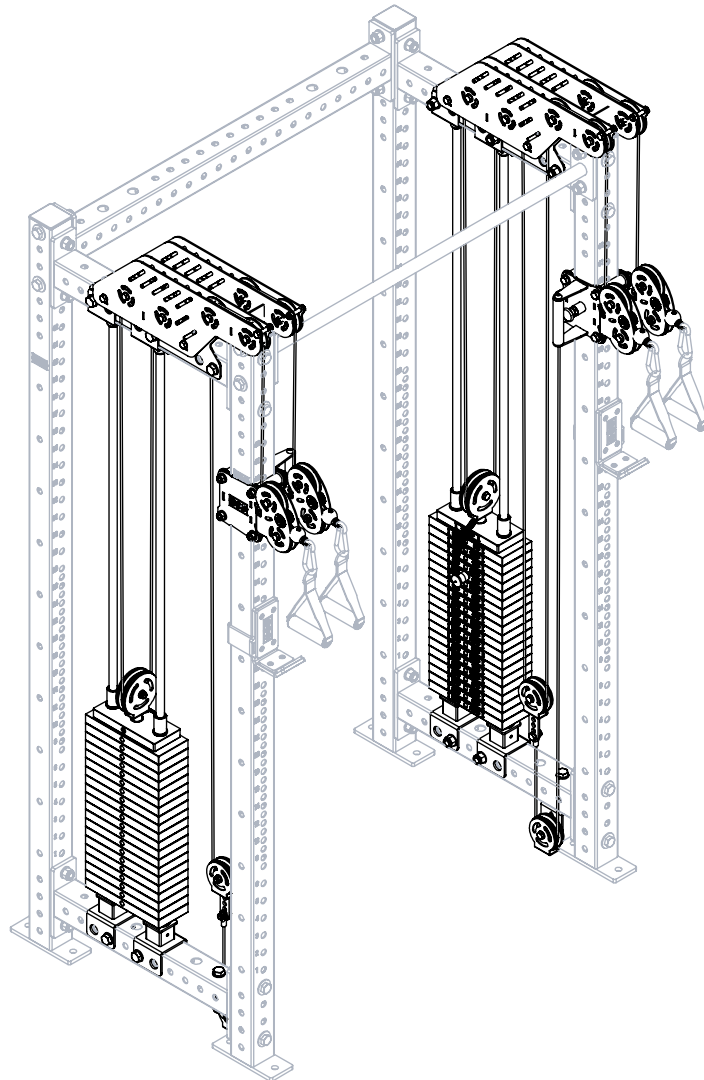

Kraken Rack Attachments For 4 Post Hydra Racks - Weight Stack

SKU: 4P-84H-STK-KRAKEN-HDR-SET



ASSEMBLY INSTRUCTIONS



BellsOfSteel

Scan QR code for assembly instructions:



www.bellsOfsteel.com | www.bellsOfsteel.us | Telephone: 1-888-718-7997



Kaevon Khoozani
President

Welcome to Bells of Steel, you've made an excellent choice.

First off I want to say thank you for supporting my small business.

I've spent a lot of time crafting this design to create a fantastic lifting experience to help you reach your full potential and I hope you love your new equipment.

I've done my best to keep the setup of your new gear simple. If you find yourself needing a bit more assistance than the included instructions, check our youtube page for assembly videos or feel free to email us for troubleshooting guidance.

A GUIDE TO SAFETY

We know you are excited to use your new Bells of Steel gear, but please read through this Guide to Safety to ensure you do not hurt yourself or others while exercising. It is your responsibility to ensure that all users of the equipment are informed of all warnings and instructions in this manual. **TO REDUCE THE RISK OF SERIOUS INJURY, READ THE FOLLOWING IMPORTANT PRECAUTIONS BEFORE USING YOUR BELLS OF STEEL PRODUCT.**

- 1 Before starting any exercise program consult your physician. Be aware of your body's signals. Incorrect or excessive exercise can be damaging to your health. **STOP EXERCISING IF YOU EXPERIENCE ANY OF THE FOLLOWING SYMPTOMS: PAIN, TIGHTNESS IN YOUR CHEST, IRREGULAR HEARTBEAT, SHORTNESS OF BREATH, LIGHTEADEDNESS, DIZZINESS, OR FEELINGS OF NAUSEA. IF YOU EXPERIENCE ANY OF THESE SYMPTOMS, STOP EXERCISING IMMEDIATELY AND CONSULT YOUR PHYSICIAN BEFORE CONTINUING WITH YOUR EXERCISE PROGRAM.**
- 2 It is your responsibility to ensure there is enough space around the product for the intended exercise. Use the product on a flat surface and ensure at least 2 feet (60 cm) of free space around it.
- 3 Children and pets must not be let on or near the product. Moving parts and heavy features of the product can be dangerous and cause serious injury.
- 4 Read all instructions in this manual before using the product and use the product only as described in this manual.
- 5 It is your responsibility to ensure that all users of the product are adequately informed of all precautions, have read and understand all warnings, and are informed how to use the product properly.
- 6 Keep hands and feet from moving parts. Do not lean or rest on the product.
- 7 Wear athletic shoes for foot protection while exercising.
- 8 Your product is intended for use in cool, dry conditions. You should avoid storage in extreme cold, hot, or damp areas.
- 9 This product is designed for indoor use only.
- 10 Ensure that any weight pins that may be included with your product are completely inserted into an appropriate weight plate.
- 11 Ensure that any handles that may be included with your product are attached securely before using the product.
- 12 Ensure that any nuts and bolts that may be included with your product are securely tightened before use. Regularly re-tighten nuts and bolts.
- 13 Ensure any cables that may be included with your product always remain attached to their proper pulleys. If a cable bind occurs during exercise, stop immediately and inspect the part to ensure any interference is fixed.
- 14 Do not overexert yourself during any exercise program. Operate the product as intended.
- 15 The product should be anchored where required or whenever possible. The product should be secured when not in use.
- 16 The product is very heavy. Improper use or assembly can lead to serious injury or death.
- 17 **SAVE AND REVIEW THESE INSTRUCTIONS.**

Now...

LET THE GAINZ BEGIN





Be sure to leave a review on our website or Amazon, we read all feedback and use it to improve our products and service.

For full warranty info visit

<https://www.bellsofsteel.com/warranty/>

Not happy with your purchase or even just changed your mind?

We offer a 30 day money back guarantee

<https://www.bellsofsteel.com/money-back-guarantee/>

Want to learn the best way to use your new products and maximize your Gainz? Subscribe to our YouTube channel for new how to's and workout videos weekly

<https://www.youtube.com/user/bellsofsteel>



www.bellsofsteel.com | www.bellsofsteel.us

PARTS LIST

- Hardware Package

No.	Description	Q'ty
3	M16 x 120 bolt	4
4	M16 x 110 bolt	8
5	M12 x 110 bolt	8
6	M12 x 80 bolt	4
7	M10 x 50 bolt	2
8	M10 x 45 bolt	40
9	M10 x 25 bolt	4
10	M8 x 20 bolt	4
13	M16 nut	12
14	M12 nut	12
15	M10 nut	46
19	∅ 16 washer	24
20	∅ 16 spring washer	12
21	∅ 12 washer	24
22	∅ 10 washer	92
25	∅ 16-25-4 spacer	2

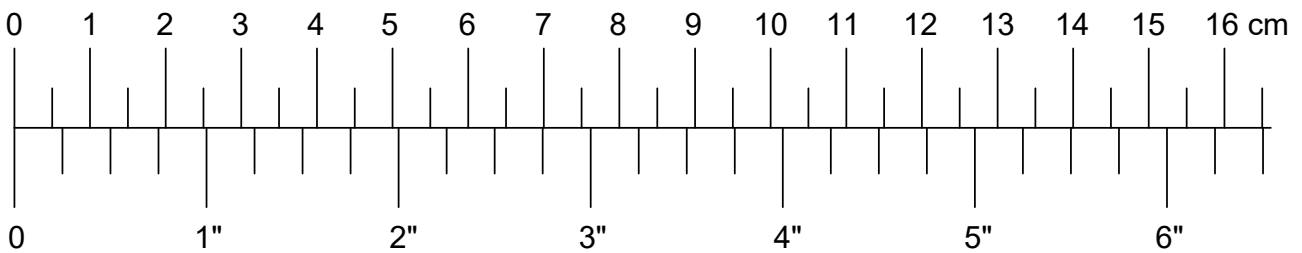

- Attached for Frames







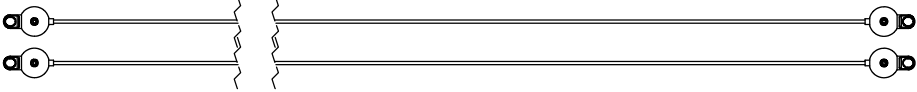

26	M10 x 16 hexagon cup head bolt	4
27	∅ 12-19-24 bushing	8
28	Popper pin	2
31	∅ 12 x 80 spring pin	2
32	Weights pin	2

- Packed in Box

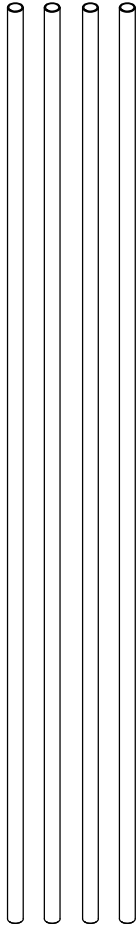
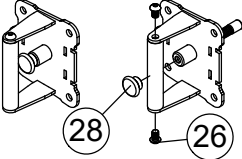
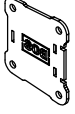
<p>③③ x 8 pcs</p>	<p>③⑤ x 28 pcs</p>	<p>④① x 4 pcs</p>
<p>③④ x 4 pcs</p>	<p>③⑥ x 2 pcs</p>	<p>④① x 4 pcs</p>
	<p>③⑦ x 6 pcs</p>	

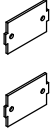
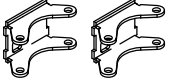
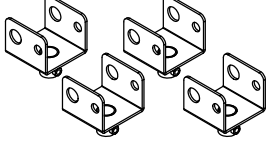
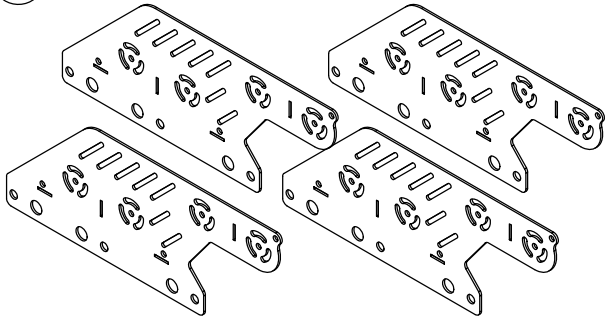
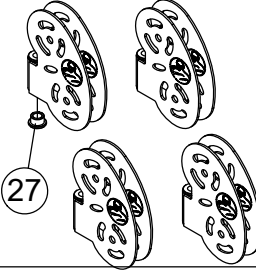
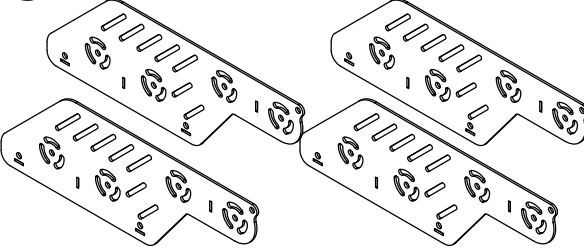
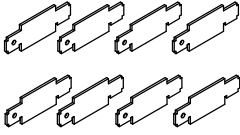
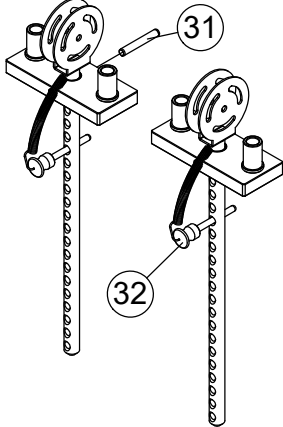
PARTS LIST

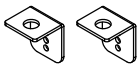
- Packed in Box

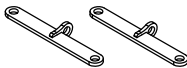
<p>④② x 2 pcs</p> 					
<p>④③ x 2 pcs</p> 				<p>⑥① x 4 pcs</p> 	
<p>④④ x 2 pcs</p> 	<p>④⑤ x 1 pc</p> 	<p>④⑥ x 1 pc</p> 	<p>④⑦ x 2 pcs</p> 		
<p>④⑧ x 2 pcs</p> 	<p>④⑨ x 4 pcs</p> 	<p>⑤① x 4 pcs</p> 		<p>⑤② x 4 pcs</p> 	
<p>⑤③ x 4 pcs</p> 		<p>⑤④ x 8 pcs</p> 		<p>⑥② x 2 pcs</p> 	
<p>⑤⑤ x 2 pcs</p> 	<p>⑤⑥ x 2 pcs</p> 	<p>⑤⑦ x 2 pcs</p> 	<p>⑤⑧ x 2 pcs</p> 		

ASSEMBLY

- Step 1.

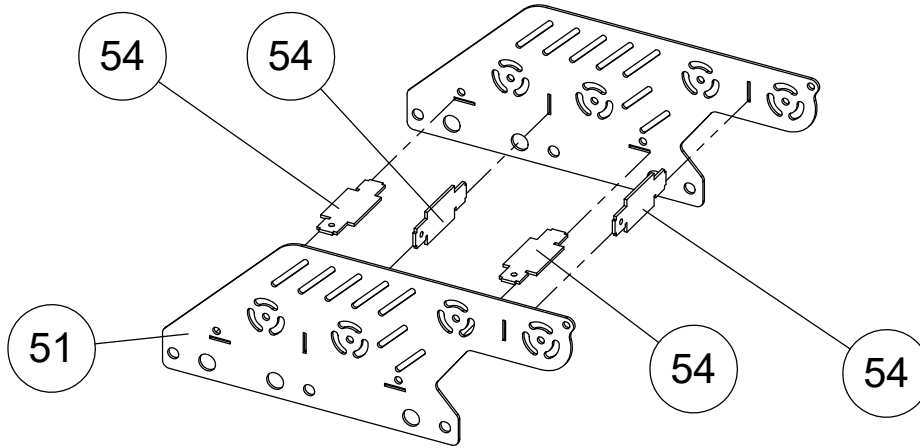

Installation of parts 54# have directional requirements.

- Step 2.

Top Pulley bracket assembly
2 sets

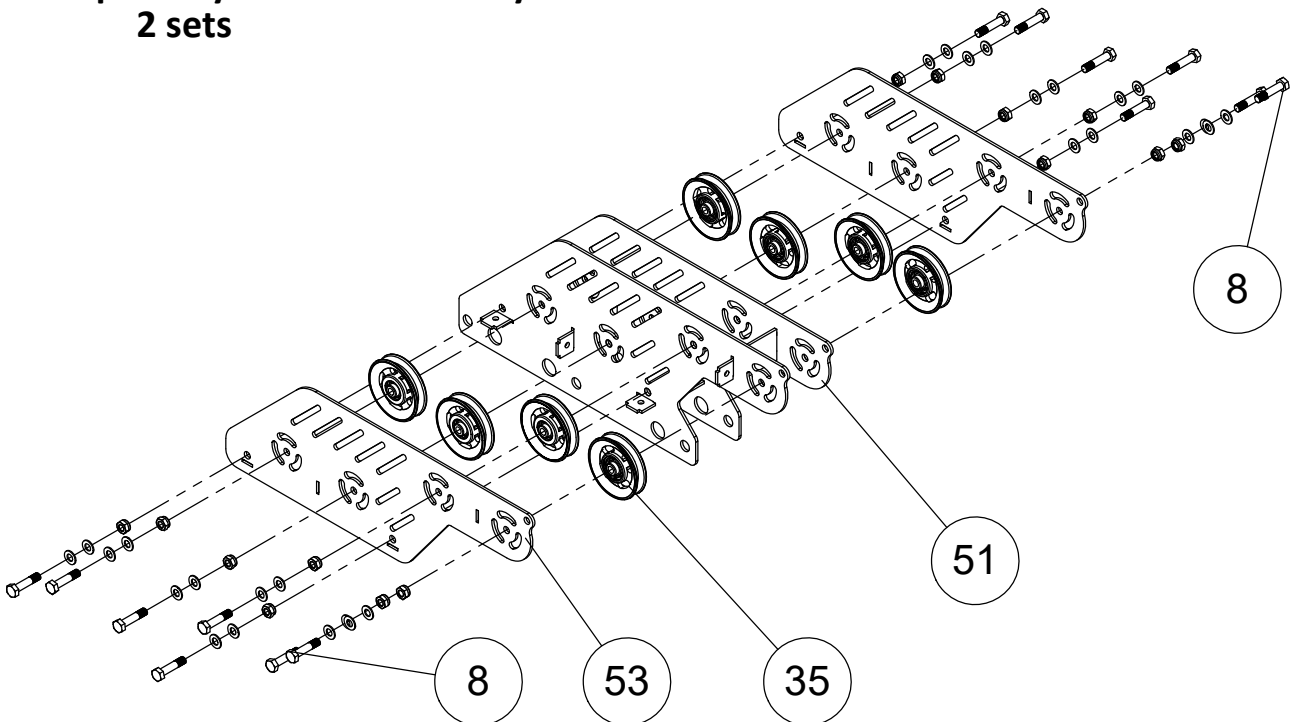

ASSEMBLY

- Step 3.

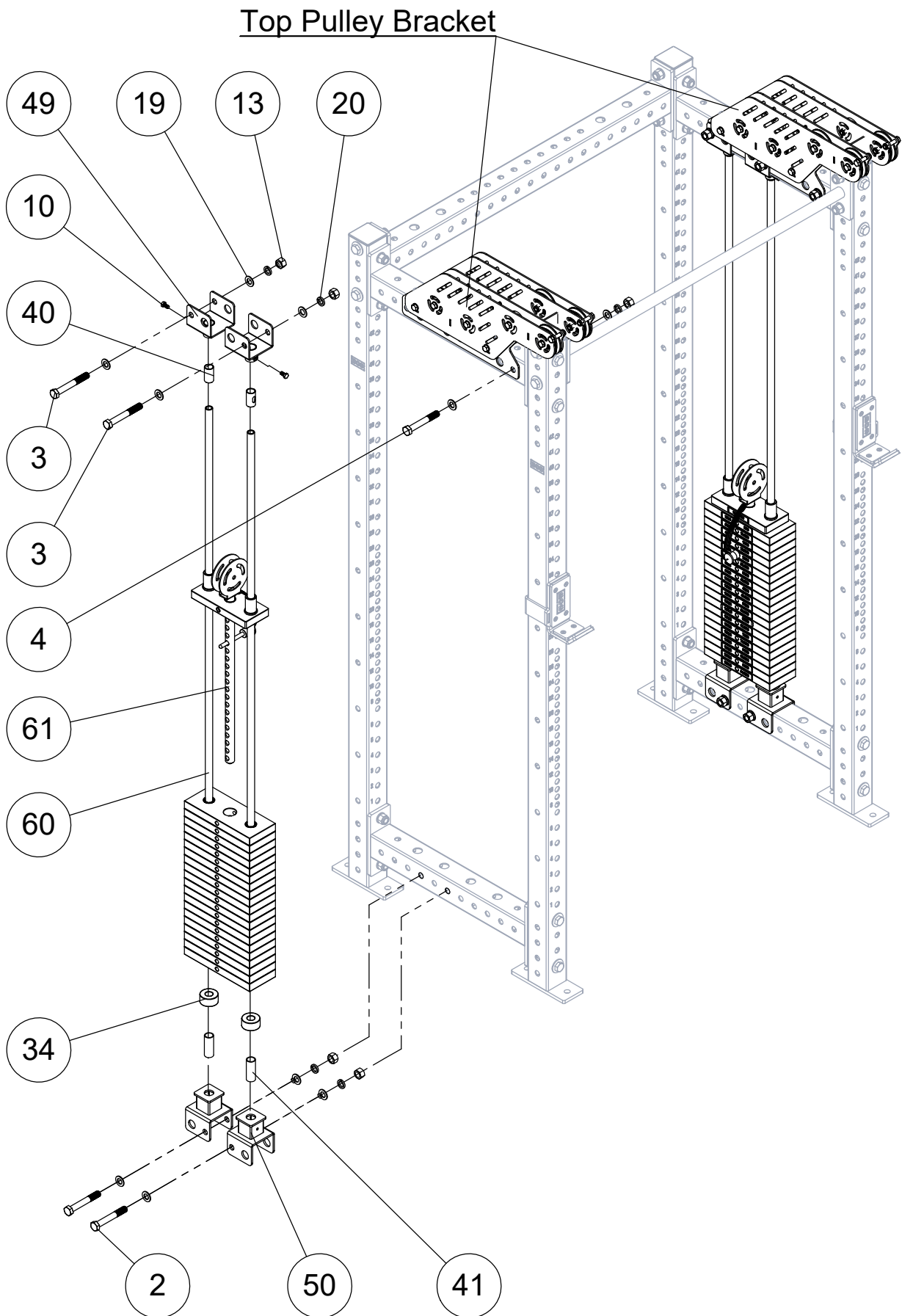

ASSEMBLY

- Step 4.

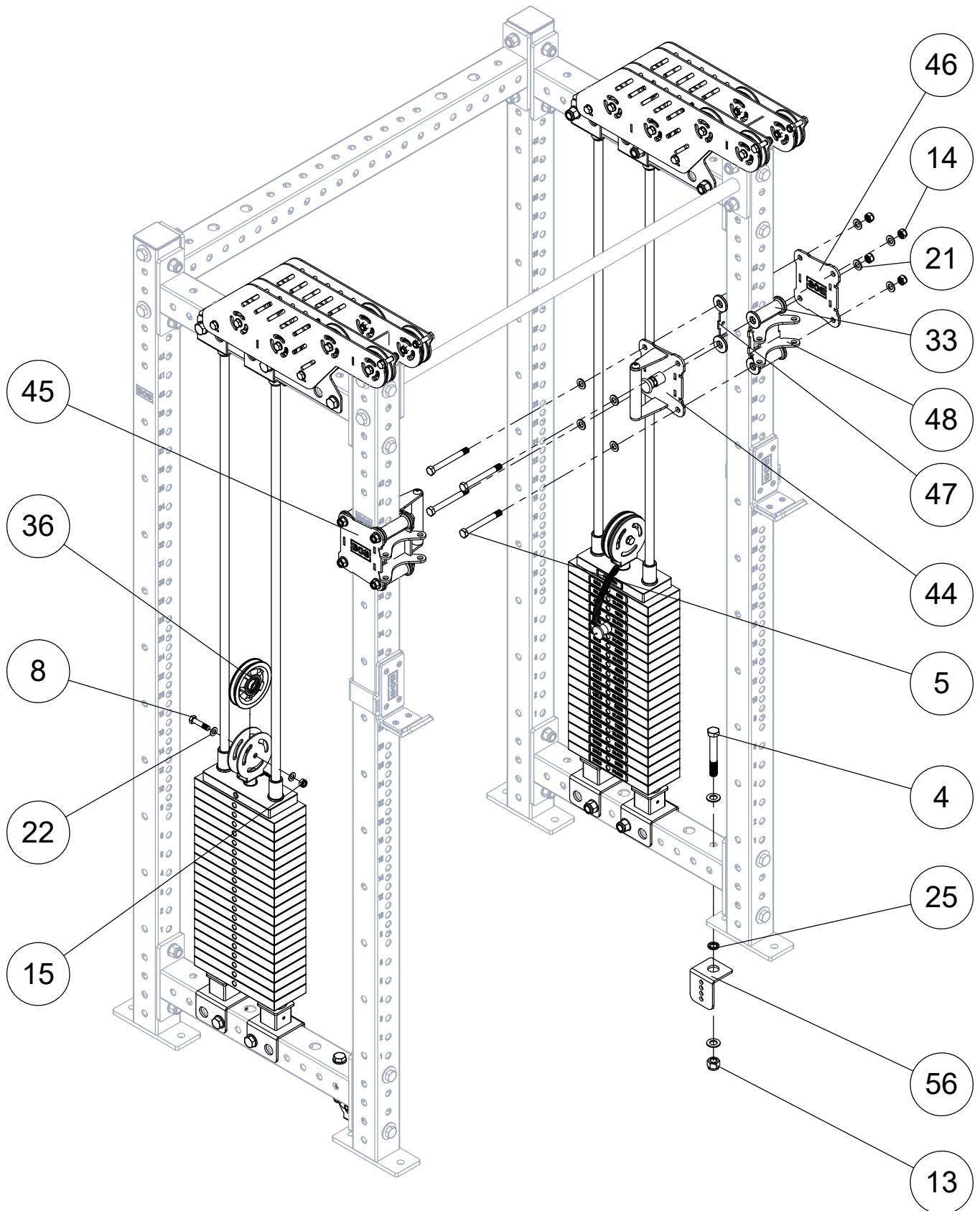

ASSEMBLY

- Step 6.

